

Werkzeugkatalog

tool catalogue

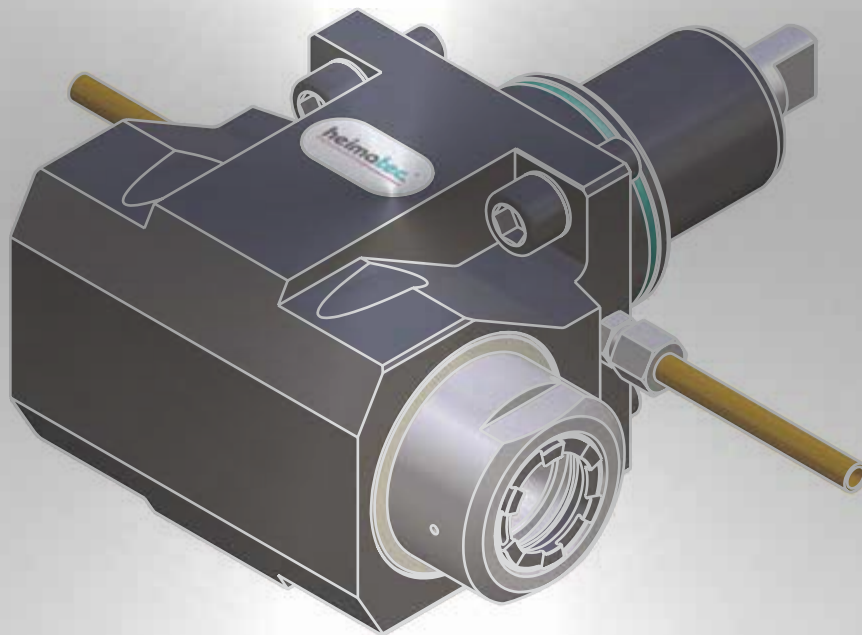

HYUNDAI KIA

SKT 200 TTSY
SKT 200 TTMS
SKT 200 TTM



Hinweis zu den AGBs:

Diese finden Sie in unserem Internetauftritt unter

www.heimatec.de

Home/Impressum/AGB

Terms and conditions:

You will find them on our website

www.heimatec.com

Home/Imprint/Terms and Conditions

Das Katalog-Werk einschließlich aller seiner Teile ist urheberrechtlich geschützt. Jede Verwertung außerhalb der engen Grenzen des Urheberrechtsgesetzes ist ohne Zustimmung der Rechteeinhaber unzulässig und strafbar. Das gilt insbesondere für Vervielfältigungen, Übersetzungen, Mikroverfilmungen und die Einspeicherung und Verarbeitung in elektronischen Systemen.

heimatec® GmbH behält sich Änderungen technischer Art jederzeit ohne Vorankündigung vor. Dies gilt insbesondere bei Anpassungen an neue oder geänderte internationale Normen oder bei Weiterentwicklungen unserer Produkte oder Herstellungsprozesse.

This catalogue, including all its parts, is protected by copyright. Each use outside the restricted limitations of the Copyright Act is inadmissible and liable to prosecution without the consent of heimatec. This is particularly valid for duplication, translation, microfilming and feeding and processing in electronic systems.

heimatec® GmbH reserves the right of technical changes everytime without advance notice, which is particularly valid for adaptations to new or changed international standards, or to developments of our products or manufacturing processes.

angetriebene Werkzeuge

driven tools



Axial-Bohr- und Fräskopf

axial drilling and milling head

$n_{max} = 6000 \text{ min}^{-1}$

8 010 66 079	ER 32 AX u-tec	EK	1:1
8 010 66 081	ER 32 AX u-tec	IK 25 bar	1:1
8 010 66 046	ER 32 AX u-tec	IK 70 bar	1:1
8 010 67 025	easy-quick HT 5	EK	1:1
8 010 67 026	easy-quick HT 5	IK 25 bar	1:1
8 010 67 060	easy-quick HT 5	IK 70 bar	1:1



Axial-Bohr- und Fräskopf

axial drilling and milling head

$n_{max} = 6000 \text{ min}^{-1}$

8 011 65 011	Kombidom/universal arbor 1"	EK	1:1
8 011 65 014	Kombidom/universal arbor 22	EK	1:1



Axial-Bohr- und Fräskopf

axial drilling and milling head

Achsversatz / offset $A=50$

8 019 65 021	ER 25 AX u-tec	EK	1:1
$n_{max} = 6000 \text{ min}^{-1}$			
8 019 65 022	ER 25 AX u-tec	IK 140 bar	1:1
$n_{max} = 6000 \text{ min}^{-1}$			
8 019 65 004	ER 25 AX u-tec	EK	1:2
$n_{max} = 12000 \text{ min}^{-1}$			
8 019 65 027	ER 25 AX u-tec	IK 140 bar	1:2
$n_{max} = 12000 \text{ min}^{-1}$			
8 019 65 023	ER 25 AX u-tec	EK	2:1
$n_{max} = 3000 \text{ min}^{-1}$			
8 019 65 024	ER 25 AX u-tec	IK 140 bar	2:1
$n_{max} = 3000 \text{ min}^{-1}$			
8 019 65 025	ER 25 AX u-tec	EK	1:3
$n_{max} = 15000 \text{ min}^{-1}$			
8 019 65 026	ER 25 AX u-tec	IK 140 bar	1:3
$n_{max} = 15000 \text{ min}^{-1}$			

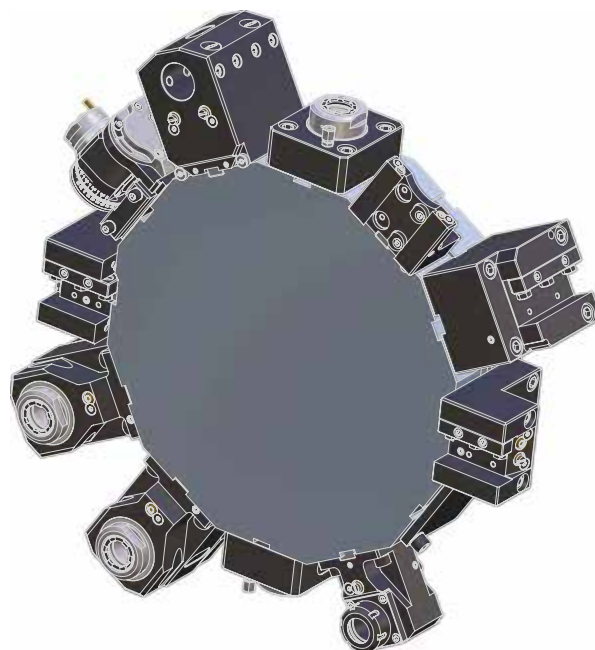

Winkel-Bohr- und Fräskopf

radial drilling and milling head

Mittenmaß / center distance $H=100$
 $n_{max} = 6000 \text{ min}^{-1}$

8 030 66 045	ER 32 AX u-tec	EK	1:1
8 030 66 102	ER 32 AX u-tec	IK 140 bar	1:1
8 030 67 059	easy-quick HT 5	EK	1:1
8 030 67 073	easy-quick HT 5	IK 140 bar	1:1



Winkel-Bohr- und Fräskopf

radial drilling and milling head

Mittenmaß / center distance $H=100$
 $n_{max} = 6000 \text{ min}^{-1}$

8 031 65 011	Kombidom/universal arbor 1"	EK	1:1
8 031 65 016	Kombidom/universal arbor 22	EK	1:1



Winkel-Bohr- und Fräskopf

radial drilling and milling head

Mittenmaß / center distance $H=100$
 $n_{max} = 18000 \text{ min}^{-1}$

8 030 65 043	ER 25 AX u-tec	EK	1:3
8 030 65 044	ER 25 AX u-tec	IK 140 bar	1:3



Winkel-Bohr- und Fräskopf radial drilling and milling head

Mittenmaß / center distance $H=100$
doppelspindel / double spindle
 $n_{max} = 6000 \text{ min}^{-1}$

8 039 66 021	ER 32 AX u-tec	EK	1:1
8 039 67 010	easy-quick HT 5	EK	1:1



Schwenkopf universal head

Mittenmaß / center distance $H=69$
Achsversatz / offset $A=60$

8 043 65 000	ER 25 AX u-tec	EK	1:1
	$n_{max} = 6000 \text{ min}^{-1}$		
8 043 65 004	ER 25 AX u-tec	IK 140 bar	1:1
	$n_{max} = 6000 \text{ min}^{-1}$		
8 043 64 008	ER 16 AX u-tec	EK	1:2
	$n_{max} = 12000 \text{ min}^{-1}$		
8 043 64 009	ER 16 AX u-tec	IK 140 bar	1:2
	$n_{max} = 12000 \text{ min}^{-1}$		

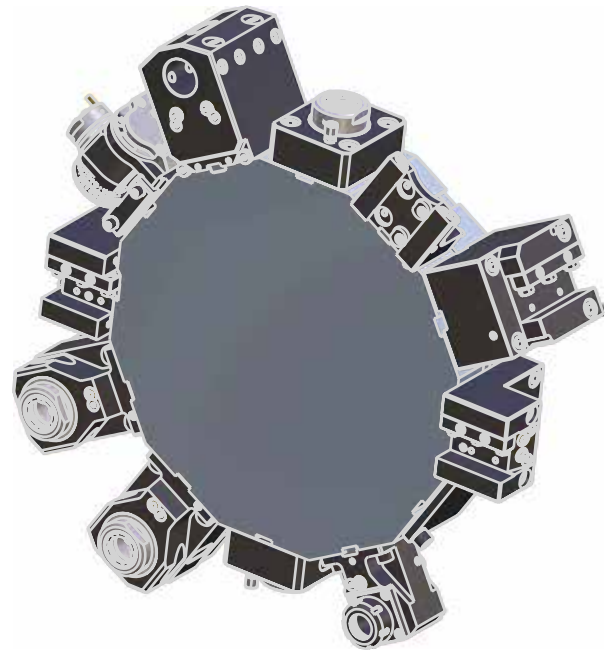

Winkel-Scheibenfräserkopf radial disk mill head

$\pm 10^\circ$ drehbar
 $\pm 10^\circ$ turnable

Mittenmaß / center distance $H=87,5$
auf 0° absteckbar / 0° can be pinned
kein Kühlmittel / no coolant
 $n_{max} = 3000 \text{ min}^{-1}$

8 037 64 002	$\varnothing 5/8''$	2:1
8 037 64 003	$\varnothing 3/4''$	2:1
8 037 65 019	$\varnothing 1''$	2:1
8 037 65 008	$\varnothing 22$	2:1

► Weitere Ausführungen auf Anfrage
further versions on request

► Zubehör **ZB...***
accessories **ZB...***



► **easy-quick**



► **u-tec**



feste Werkzeuge static tool holders

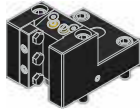

Kombi-Drehstahlhalter
universal turning holder

8 224 15 006 **Vierkant/square 25** EK
8 224 15 016 **Vierkant/square 1"** EK

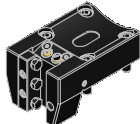

Kombi-Drehstahlhalter
universal turning holder

8 224 15 005 **Vierkant/square 25** EK
8 224 15 015 **Vierkant/square 1"** EK



Kombi-Doppel-Drehstahlhalter
combi double turning holder

8 251 15 003 **Vierkant/square 25** EK
8 251 15 008 **Vierkant/square 1"** EK



Kombi-Plandrehhalter
combi facing holder

8 244 15 005 **Vierkant/square 25** EK
8 244 15 006 **Vierkant/square 1"** EK



Bohrstangenhalter
boring bar holder

Mittenmaß / center distance H=100

8 240 18 049 **ø32** IK/EK
8 240 19 043 **ø40** IK/EK
8 240 19 051 **ø50** IK/EK
8 240 17 045 **ø1"** IK/EK
8 240 19 062 **ø2"** IK/EK



Spannzangenhalter
collet chuck holder

Mittenmaß / center distance H=100

8 240 16 026 **ER 32** IK/EK

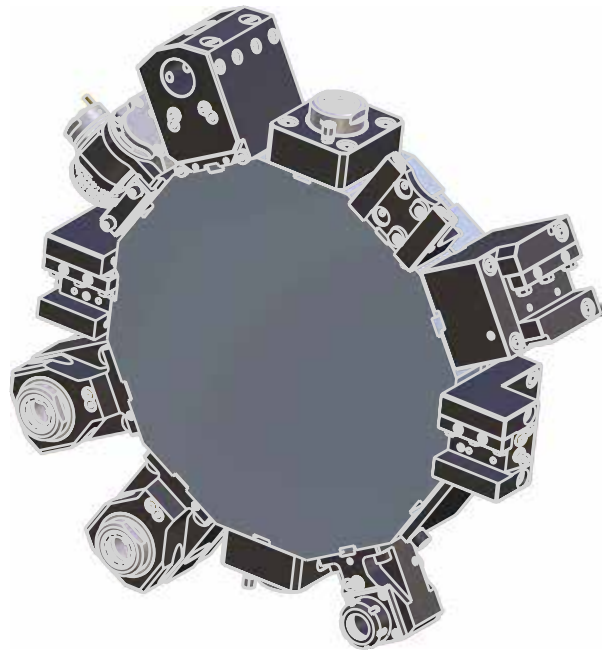

Abstechhalter
cut-off holder

8 224 13 015 **SH 32** EK



Abstechhalter
cut-off holder

8 224 12 014 **Vierkant/square 25** EK
8 224 12 020 **Vierkant/square 1"** EK

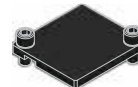

Abdeckblech
cover plate

8 200 03 005

HYUNDAI KIA SKT 200 TTSY/TTMS/TTM

Hauptsitz/headquarters

heimatec® GmbH
Präzisionswerkzeuge
Carl-Benz-Straße 4
D- 77871 Renchen
Postfach 11 36
D- 77867 Renchen
Tel.: +49 (78 43) 94 66 0
Fax: +49 (78 43) 94 66 66
www.heimatec.de
info@heimatec.de

heimatec® Inc.
16 E. Piper Lane Suite 121
USA- 60070 Prospect Heights IL
Tel.: +1 (847) 749 0633
Fax: +1 (847) 749 2445
www.heimatecinc.com
info@heimatecinc.com

heimatec® - Ost, JSC
ul. Kozjubinskogo 4 office 209
RUS- 121351 Moskau
Tel.: +7 (495) 648 69 19
Fax: +7 (495) 648 69 19
www.heimatec-ost.ru
sales@heimatec-ost.ru

